

# Installation and Service Manual for INFINITI Dosing Pump



aCCura-Mini without control

v.01

# Mini and micro dispensing solutions for fluids and pastes

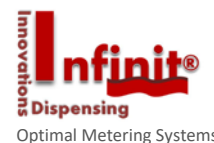

## 1 INTRODUCTION

Dear ladies and gentlemen!

First of all, we would like to congratulate you for buying INFINITI products, allowing you to work with the latest technology. To be able to avoid malfunctions, some important criteria now follows for commissioning your INFINITI product and the servicing afterwards. Furthermore, we see it as our utmost duty to inform you about possible dangers in accordance with the operation of your new pump.

Therefore, please note, that this manual needs to be within the near of your service and other related personnel during, before and after operation of the pump.

We emphasise the need for reading this manual carefully and would like to point out, that important notices relating your security will follow within the next pages of this manual.

Understanding all notices and the technology related information allow you to operate your latest INFINITI product without endangering yourself and others.

We wish you success and all the best with your newest INFINITI Dosing product.

The INFINITI dosing team

# Mini and micro dispensing solutions for fluids and pastes

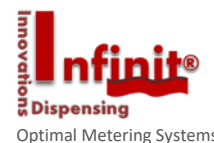

## 1.1 Use compliance

Before operation, please carefully read the following

1. Please intensively study this manual before commissioning. Do get familiar with the operation manual before each start of the pump or every time when the operator changes.
2. Please note, that this manual is part of this particular pump even when being moved to another department or company.
3. The pump may only be used by healthy people
4. Do only use INFINITI spare parts. Damages caused by using other parts are not supported by the INFINITI warranty.
5. Should any of this manual not be clear or understandable, please do contact your distributor or write us under [info@infiniti-dosing.com](mailto:info@infiniti-dosing.com).

This pump is a self-priming endless dosing pump. Following materials may be used with it for metering or transferring:

- Adhesives and sealants with or without spheres
- Material resistant fluids and pastes
- Oils and lubricants
- Paints and lacquers

Do not use with cyanoacrylates, anaerobic glues or any explosion rated nor poisonous products. Please do contact your distributor for further information. We are not chemical specialists so please do check the pump material resistance of all wetted parts with your product supplier. Any improper use will produce the loss of the support of the INFINITI warranty.

Explicit compliance for the pumped material:

Depending on the application, the maximum temperature may not exceed 120°C. With the use of aggressive products, please do always contact your distributor and product supplier to get approval before operation and or commissioning.

Make sure, that the local legislation has been incorporated all safety relevant demands are being kept.

Changes done by the user result in loss of warranty. All damage claims upon will be ignored. All safety relevant technical issues lose the INFINITI warranty support.



**This sign shows a safety relevant message. Make sure all operator personnel and safety people take note or have been made aware.**

*All rights reserved. This manual may not be duplicated without written agreement of the manufacturer.*

# Mini and micro dispensing solutions for fluids and pastes



## 1.2 Safety instructions

- Make sure, that you have taken care of the rules for accident prevention next to reading this manual.
- Do not disregard any caution sign; they give important notices to prevent accidents or injuries. Caution signs are an important part of the safety rules for accident prevention therefore need to be visible at all times.
- Before commissioning, please do check all screws and see if they are well tightened.
- Before starting to work with the pump, every worker needs to fully understand the application and its demands. Do not let the pump run without any supervision.
- Service and repairs may only be performed via trained personnel and the relevant tools.
- All needed accident prevention apparatus and fixtures must be installed before operation. Make sure they are in good condition at all times.
- Make sure that the pressure in the system has been neutralized while servicing the pump. Switch off the power.
- In case solvents are used, it may be needed to wear breathing protection masks. Please ask your safety staff.
- Never smell at openings after demounting the pump!
- Take the needed precautions when working in an explosion proof zone!
- Smoking is prohibited in the near of solvents and other inflammable products.
- Only work on the pump and the pump drive shaft when the power is off.
- Do not let the pump dry run.
- Make sure that the suction side connection is vacuum proof and that the connection of the pressure side is able to withstand the system pressure.
- Do not use demineralised water.

# Mini and micro dispensing solutions for fluids and pastes



## 2. Technical description, function and assembly

Basically, all INFINITI pumps can be used for dosing or transferring (pumping) or emptying applications:

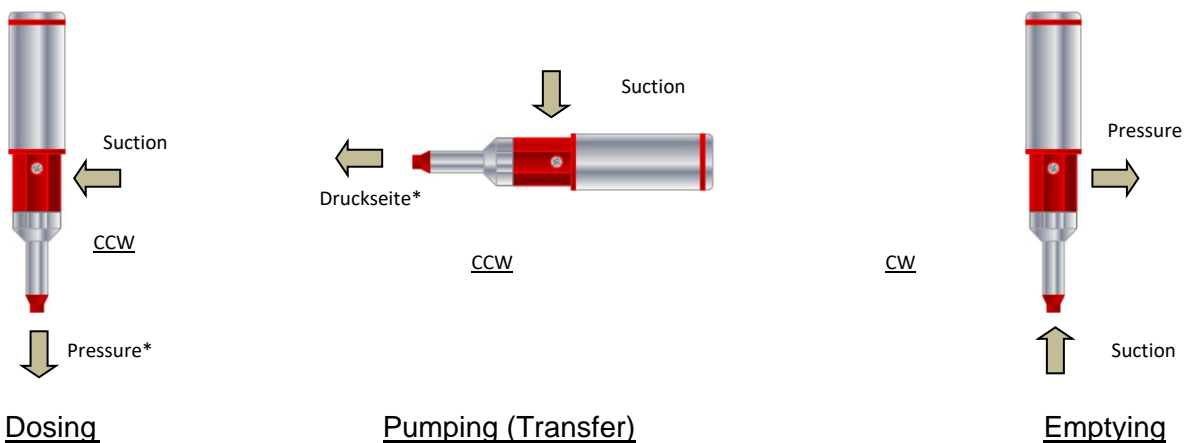

INFINITI pumps in general can be used in two directions: Clockwise or Counter Clockwise. Furthermore, the position/angle of the pump almost does not have any effect on the pumping or dosing result. Only in some cases, the suction performance can be influenced by it.

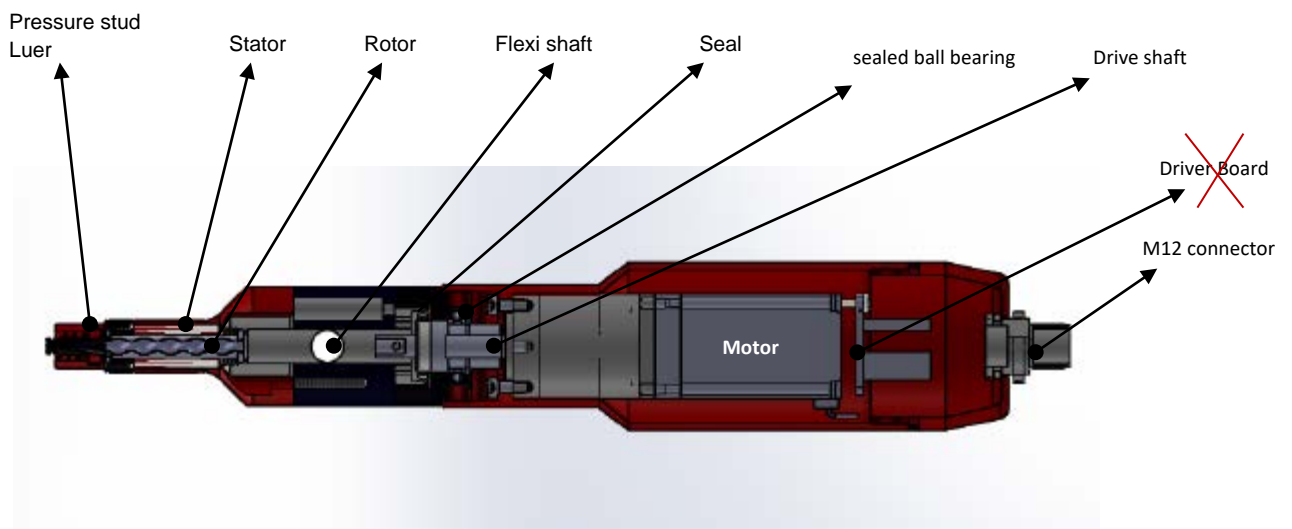

## Mini and micro dispensing solutions for fluids and pastes

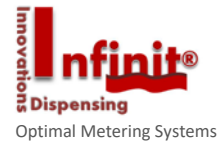

INFINITI Dosing technology is based on the endless dosing progressing cavity pump. The rotating element "Rotor" and the static counter part "Stator" form an optimal chamber "Cavity". Both rotor and stator touch each other over the whole length to create a continuous seal that prevents backflow even with higher back pressure. The movement of the rotating rotor in the stator allows the fluid to be gently pushed to the next chamber without shearing and squeezing the fluid. (picture 1).

Due to the fact that the cavity along the sealing line is always open, particles can be handled without difficulties. INFINITI technology will pump and dose abrasive fluids but also more viscous pastes whenever the chambers are correctly and completely filled.

INFINITI Rotors are manufactured to resist many chemical materials according CE conformity. The high degree of smoothness of the rotor surface prevents fast wear and tear and provides long life cycle time.

INFINITI Stators have been developed to offer less friction.

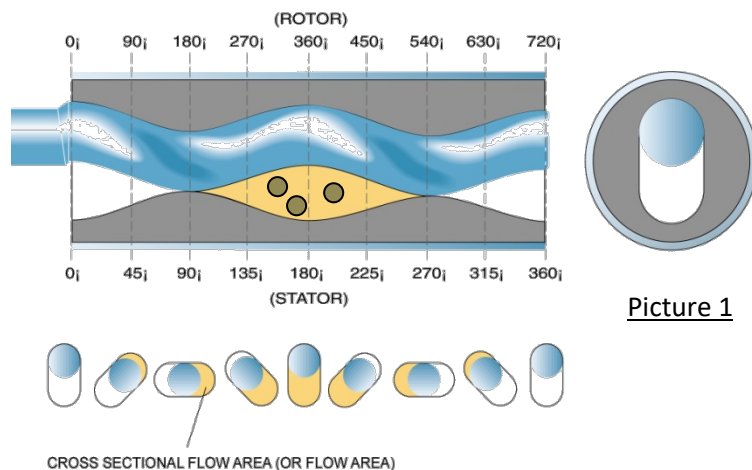

Picture1:

*Shows the possibility to convey particles and a gentle flow of the material (yellow).*

*The dosing volume is independent of the rotor (blue) position since the cavities have a defined volume.*

*Therefore, PCP technology is optimal for dispensing.*

Driving the pump counter clockwise CCW conveys the fluid or paste from the suction side towards the pressure side in picture 1 from left to right. To empty vessels or bottles, in general the flow should go from right to left meaning clockwise CW. INFINITI pumps can be used in continuous or indexed applications.



**Avoid dry running! Do not test with water!**

# Mini and micro dispensing solutions for fluids and pastes

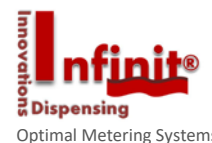

## 3. Commissioning or starting up

### 3.1 General notice

- Make sure you are aware of the safety instructions under 1.2 and your local legislation
- Make sure enough material is available
- Make sure all connections are well tightened and sealed
- Make sure all pump materials are compatible and resist the product

### 3.2 Trials

Testing with water can cause loud noises and destroy the stator. Reason for this effect is the lack of lubrication by water. You may use Vaseline oil or glycol instead or insert an EPDM based stator (if available). Fluor elastomers such as Viton®, Viton Extreme are to be completely avoided with water. Alternatively you may test with the product used for the application or also mesamol. Demineralised water is restricted for use at all times because it may attack all pump materials. Please ask your distributor.

### 3.3 How to avoid dry running

Since the rotor made of metal is running in an elastomeric rubber stator, heat can be produced when no material is being transported due to the lack of lubrication. There cannot be any heat dissipation because the rubber stator is working like a shield. A continuous friction builds up increasing heat that cannot be controlled therefore the stator material can be destroyed rapidly relative to the pump speed. Possible solution: Start the pump slowly at max. 10 rpm for max. 1 minute and/or pre-fill the pump.

### 3.4 Calibration (If available. Please see handbook electronics/controls)

Calibration is a process to enable the control box to understand about the volumetric filling degree of the pumps cavities when it is being used for dosing or dispensing. Only by performing this process you will reach the highest accuracy offered by INFINITI®.

The calibration can be performed many times. We suggest to recalibrate every time you change the material or nozzle. Furthermore, recalibration may elongate the use of your INFINITI Dosing pump after having used it for a longer period; the process will incorporate possible low wear of the stator. *You can easily calibrate by using a scale, start 1 round, calculate the steps and divide taking into account the Specific Weight.*

### 3.5 Position of the pump

Basically, all INFINITI pumps can be positioned in any direction. Nevertheless, please consider the following:

## Mini and micro dispensing solutions for fluids and pastes

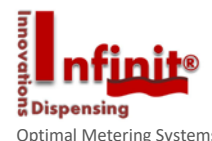

**3.5.1 Dosing and transferring:** please do not exceed 6 bar pressure on the pump suction side. Keep the pressure constant to avoid bad dosing results. In case needed, use a pressure reduction valve. Avoid backpressure of >10 bar (145 psi) on the pressure side.

These are theoretical values made with water at 22°C (71.6 °F). Higher pressures can be reached according the material viscosity and pump speed. Please adapt the nozzle and needle in length and diameter to decrease backpressure. By using conically shaped needles, the backpressure can be decreased so the suckback optimised.

**Notice:** We suggest using tapered needles whenever possible

**3.5.2 Emptying:** Stainless steel bodied pumps can be used up to 15 bar (217 psi). Plastic versions should not be used above 7 bar (100 psi). In both cases, you will be able to reduce the seal wear.

### 3.6 Commissioning

- Open the leakage control which you can find opposite of the material entrance which is sealed with an o-ring. Gently pre-fill the pump when possible, by using low pressure steps. **Give the product enough time to flow!** As soon as material comes out of the bore, you may close the leakage bore. **See 4.1.1 under I**
- Start the pump with low speed (=filling program) until the material comes out thru the nozzle without air bubbles. It is wise to put the needle after the bleeding process. You may put the nozzle up to bleed the air.
- Now start the calibration process if available. You will need at least a 3 digit scale.
- After the calibration, you can set the dosing volume or speed and start the operation.

**Notice:** A restart after changing the software parameters could become possible.

### 3.7 Pump speed table

Following values are only an orientation support and not scientifically proved:

Product (cP ≈ mPa.s)	Speed	Suction pressure
Water like fluids	Till 100%	ambient
Honey like pastes	Max. 80%	1-3 bar (14.5 - 43.5 psi), Max. 3 bar (43.5 psi)
Oils, greases till 25.000 mPa.s	Max. 70%	2-3 bar (29 - 43.5 psi), Max. 4 bar (58 psi)
Oils, greases till 50.000 mPa.s	Max. 50%	3-4 bar (43.5 - 58 psi), Max. 5 bar (72.5 psi)
Silicone und Epoxies not filled	Max. 80%	3-4 bar (43.5 - 58 psi), Max. 6 bar (87 psi)
Silicone und Epoxies filled	Max. 60%	3-5 bar (43.5 - 72.5 psi), Max. 6 bar (87 psi)
UV-adhesives	Max. 90%	1-2 bar (14.5 - 29 psi), Max. 3 bar (43.5 psi)
Pastes till 50.000 mPa.s	Max. 50%	3-5 bar (43.5 - 72.5 psi), Max. 6 bar (87 psi)
Pastes over 50.000 mPa.s	Max. 20%	Max. 6 bar (87 psi)



## Mini and micro dispensing solutions for fluids and pastes

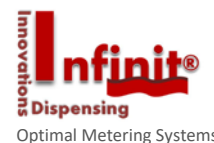

In almost all applications, the material flowability is essential for a good dispensing result. **Make sure, that the pumps cavities are completely filled at max. dosing speed.** The material flowability is crucial for the pumps speed therefore do not just start the pump without thinking about the rheology\* of the product. The suction side pressure and pressure side back pressure together with the dosing velocity are key for the long life time of your INFINITI pump.

*\* fluid science and flowability according molecular structure*

### 4. Mounting and dismantling

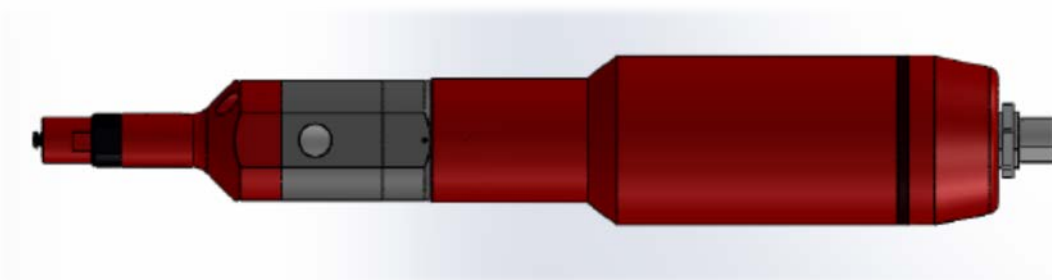

The aCCura-Mini has been developed for dispensing applications, has been assembled with utmost care and leave our factory tested. The easy design is functional and does not need much tools:

**Allen/hex keys for M3 and M2.5 screws.**

#### **Notice:**

The rotor and drive shaft are assembled as one piece only. The total rotor-drive-shaft cannot be dismantled. In case needed, please send it back to your local distributor or the factory.

# Mini and micro dispensing solutions for fluids and pastes

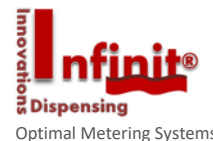

## 4.1 Assembly and Mounting

All pumps come mounted and tested directly from the factory.  
In case you receive separate parts, please do check if you have received original parts.  
Otherwise, you will not be guarded by the manufacturer's warranty.

### 4.1.1 Assembly

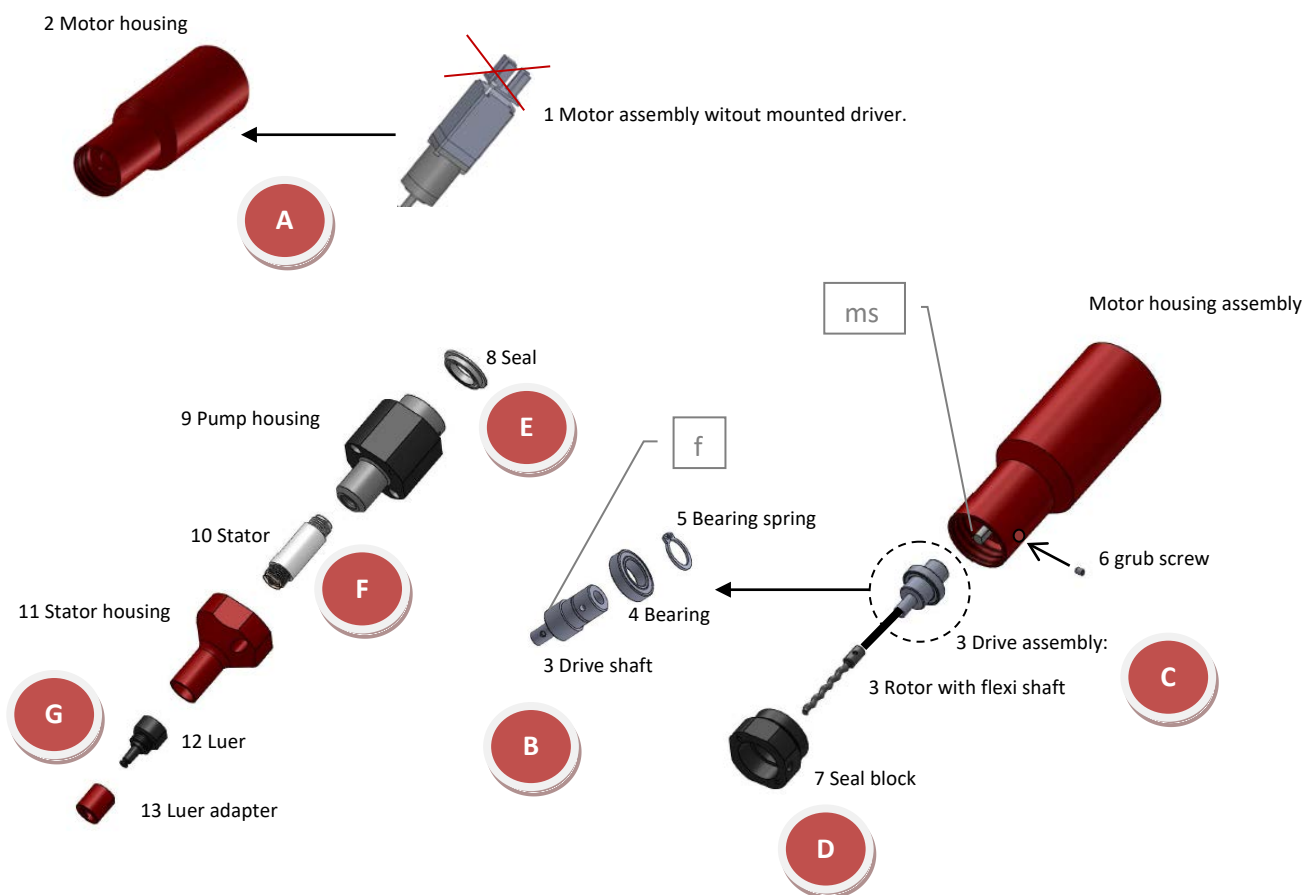

A. Slide the motor assembly (1) into the motor housing (2), position it and tighten them together with 4 x hex screws M3 x 8 (19).

B. **Do not use any tools to grab the drive shaft (3).** This may cause injuries to the surface. The front surface (f) will be used for the seal (8). The drive shaft should come as a unit mounted with the rotor and the flexible shaft; the drive assembly (3). Mount the ball bearing (4) onto the drive shaft (3) by hand or use a centering tool. Do not use high force. Use the correct tool to slide the bearing spring (5) into the groove. Make sure it is well positioned.

# Mini and micro dispensing solutions for fluids and pastes

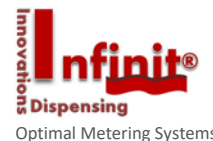

C. You may put the grub screw (6) into the M3 hole of the drive shaft (3). Slide the drive assembly (3) onto the motor shaft (ms) until it completely fits the end position. Tighten the grub screw (6) thru the hole of the motor housing (2). Only hand tighten it and make sure that the drive shaft assembly cannot turn.

D. Attach the seal block (7) to the motor housing (2) by rotation until it reaches the end position. Do not use a tool. Do not use high force.

E. Put the seal (8) in the pump housing (9). The flat side should show outside. You may feel some resistance putting the seal in place.

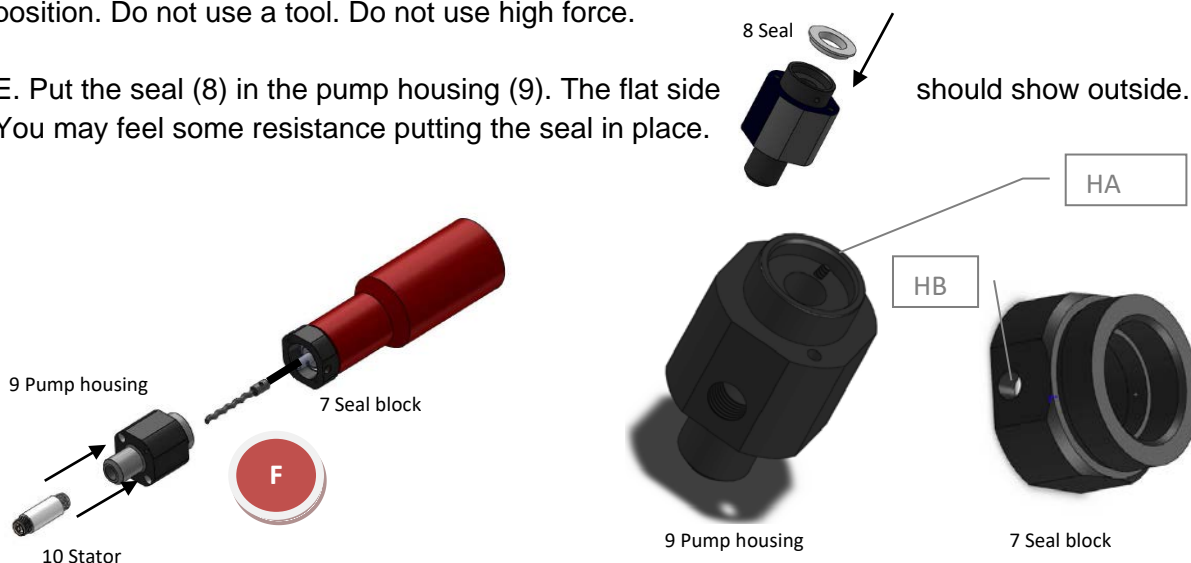

F. Slide the pump housing (9) into the seal block (7) and make sure, that both wholes (HA, HB) are positioned over each other. Connect them with the 2 hex screws M3 x 10 (20). Put on the stator (10) and tighten it by hand only. **Please check 4.1.1.1 on the over next page!**

Now slide over the stator housing (11) and hand tighten it with the 2 hex screws M3 x 10 (21).

and hand tighten it with the 2 hex screws M3 x 10 (21).

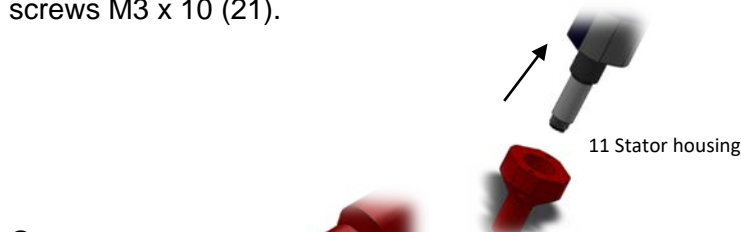

G.

Complete the pump by turning on the Luer (12) followed by the Luer adapter (13). Tighten them by hand. The Luer has an O-ring (23)!



*Notice: in case the stator (10) starts turning during the pump operation, you may secure via an M3 flat headed screw on the side of the stator housing(11).*

## Mini and micro dispensing solutions for fluids and pastes

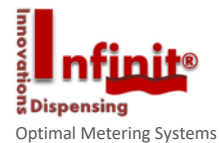

H. Slide over the motor cover ring (15) onto the motor cover (14). Gently put the M12 connector (16) thru the 16 mm whole of the motor cover (14) and screw them together. Make sure you do not hurt and wire! Now slide over and tighten the screw nut (17) by hand. Make sure the M12 connector (16) does not turn to avoid the wires inside from getting squeezed-off.

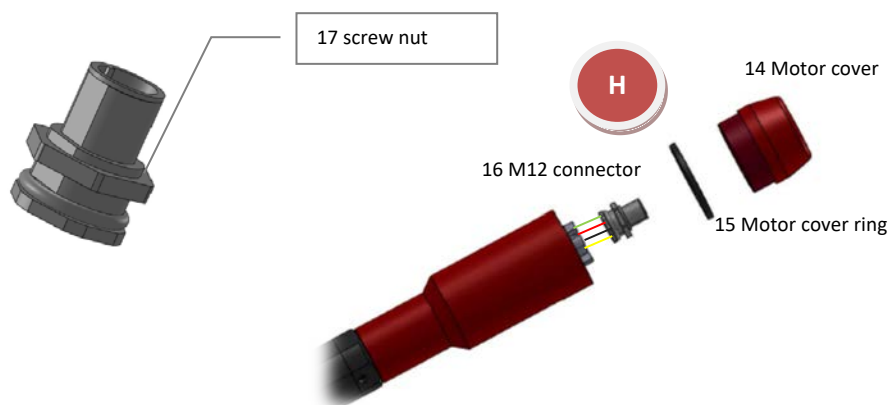

I. Introduce the viton O-Ring (18) into the leakage bore of the pump housing (9) and tighten it with an M3 x 6 screw (22).

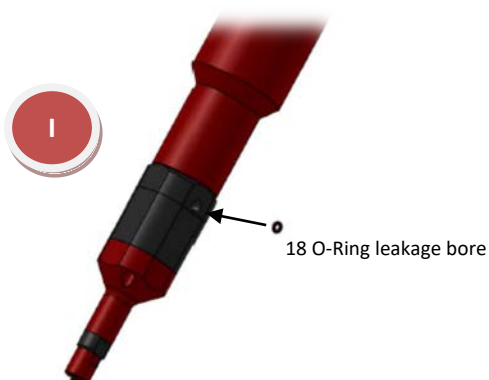

## Mini and micro dispensing solutions for fluids and pastes

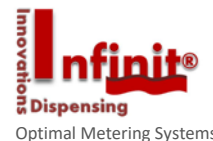

### 4.1.1.1 Stator

The Stator (10) is made of a soft elastomer and is the counter piece to the metal rotor (3). Depending on the model, the rotor (3) may also be a polymer). The stator has a fine M10 x 0.5 thread. Turn in the Stator (10) to into the pump housing putting the rounded surface side towards the motor.

This allows the fluid to better flow in.



The stator (10) must gently slide over the Rotor (3) by means of a turning movement. Do not use high force! Do not just push the rotor into the stator! In case the needed force is too high, you may use vaseline oil or glycol.

### 4.2 Dismantling (for cleaning or after wear)

Should your aCCura show irregular dispensing results and a recalibration does not help, then possible wear of the stator may be the reason for inaccurate results. On top, leakage of fluids thru the nozzle and increasing pulsation may be indications of wear of the stator.

Start dismantling the pump in the opposite way of 4.1 but skip H. Do only dismantle the motor with driver in case you fear the motor and/or driver are malfunctioning.

**Please be aware, that the motor might be hot!**

*Notices: Should the dispensing material not be black but you can see black residual parts on the rotor, then this may be an indication for incompatibility of the material with the stator elastomer. Ask your dealer!*

⚠ Never smell the product to check the compatibility consistency!

⚠ Do not touch the material with bare hands!

Clean only with a soft cloth. Only use solvents compatible with POM. Do not use any hard or metal brush to clean out the threads or any parts; this may destroy the parts.

## Mini and micro dispensing solutions for fluids and pastes

 Use protective gloves!

**Infiniti®**  
Innovations  
Dispensing  
Optimal Metering Systems

Clean the visible part of the rotor and check if you can detect any wear. If you can see and feel wear like in the picture then you will have to exchange the rotor-drive-shaft. Generally, the stator (10) needs exchange in that case.

*Only in little cases, the wear shown in the picture does not result in refurbishment.*

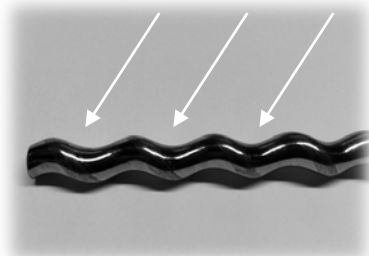

If only the stator (10) needs to be exchanged, please refer to point 4.1.1.1 for assembly.

### **Important notice about the seal:**

Avoid the seals getting damaged by assembly and dismantling. Only use gentle force by hand and no tools to release the seal(s).

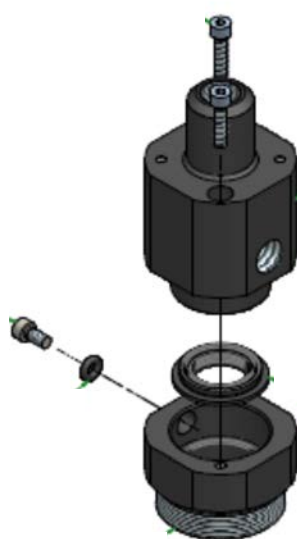

Wet seal



**The rotor-drive-assembly is made of 1 piece only and cannot be dismantled. Please only use inert lubricants for assembly. Generally, they are not needed and can leave unwashed residue. Never use silicone based lubricants for automotive applications because they are forbidden.**

## Mini and micro dispensing solutions for fluids and pastes

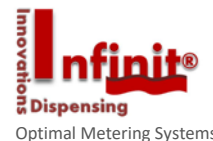

### 4.3 Leakage

The pump is equipped with a leakage detection in the front of the pump housing (9). Whenever product comes out of the bore, you immediately have to stop the motor and dismantle the unit. **See 4.2**

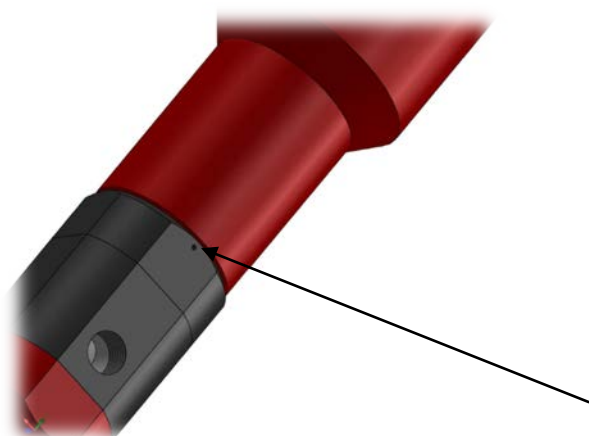

## 5. Service and -intervals

Due to the many different materials and applications, it is very difficult to suggest an accurate plan for service. Factors which influence the intervals:

1. Operation and environmental temperature
2. Viscosity, abrasiveness, aggressiveness of the material
3. Pump speed
4. Worker and service personnel
5. Cleaner and cleaning fluids

We suggest to use INFINITI pumps according the physical and possible properties of the design. Clean always with thoroughness. Further more, we suggest to exchange the wearing and tearing parts (see point 7) each 1/2 year with 8/5 operation mode. Wet lubricants without particles may need exchange only after 12 months with 8/5 operation mode.

Elastomer parts with a shelf live of more then 1 year, should not be used any more. Elastomers age over time and loose their properties.

Do only use original spare parts.

Housing parts can be cleaned with a soft tissue and an inert cleaning fluid.

# Mini and micro dispensing solutions for fluids and pastes

## 6. Drawings

Please ask your dealer or send us an email if you want to receive the PDF drawings:

[info@infiniti-dosing.com](mailto:info@infiniti-dosing.com)

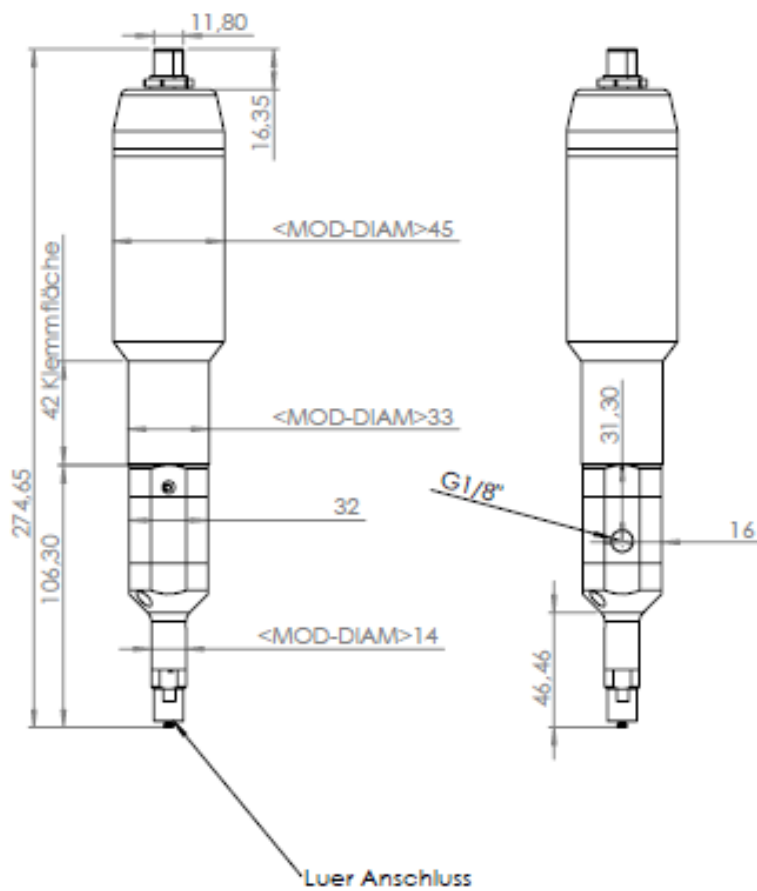



# Mini and micro dispensing solutions for fluids and pastes

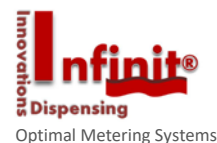

## 7. Parts list

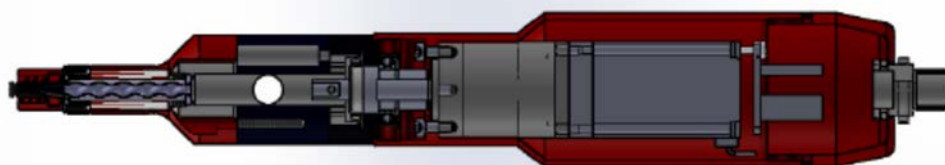

W = wearing part (no warranty), should be kept on stock

S = spare part

Number	Article	Description	Amount	Part
1		Geared stepper motor without driver	1	S
2		Motor housing, aluminium	1	S
3		Drive assembly with rotor (stainless, polymer)	1	W
4		Ball bearing, sealed	1	W
5		Bearing spring	1	S
6		Grub screw, M3	1	S
7		Seal block, POM	1	S
8		Seal, polymer with stainless spring (or other)	1	W
9		Pump housing, standard POM	1	S
10		Stator, elastomer (standard Viton)	1	W
11		Stator housing, Aluminium	1	S
12		Luer, POM	1	W
13		Luer adapter, Aluminium	1	S
14		Motor cover, Aluminium	1	S
15		Motor cover ring, POM (different colours)	1	S
16		M12 connector, Conec	1	S
17		Screw nut, Conec	1	S
18		O-Ring leakage bore, Viton	1	W
19		M3 x 8, hex screw motor, stainless	4	S
20		M3 x 10, hex screw, stainless (pump housing)	2	S
21		M3 x 10, hex screw, stainless (stator housing)	2	S
22		M3 x 6, hex screw, stainless (leakage bore)	1	S
23		O-ring, viton, Luer	1	W

## Mini and micro dispensing solutions for fluids and pastes

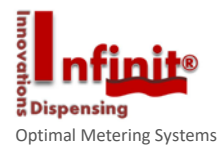

### 8. Integration

You can use your aCCura for static applications. The body weight and shape have been ergonomically designed for easy use.

Furthermore, you can integrate your aCCura-Doser by clamping it onto an XYZ or table top robot.

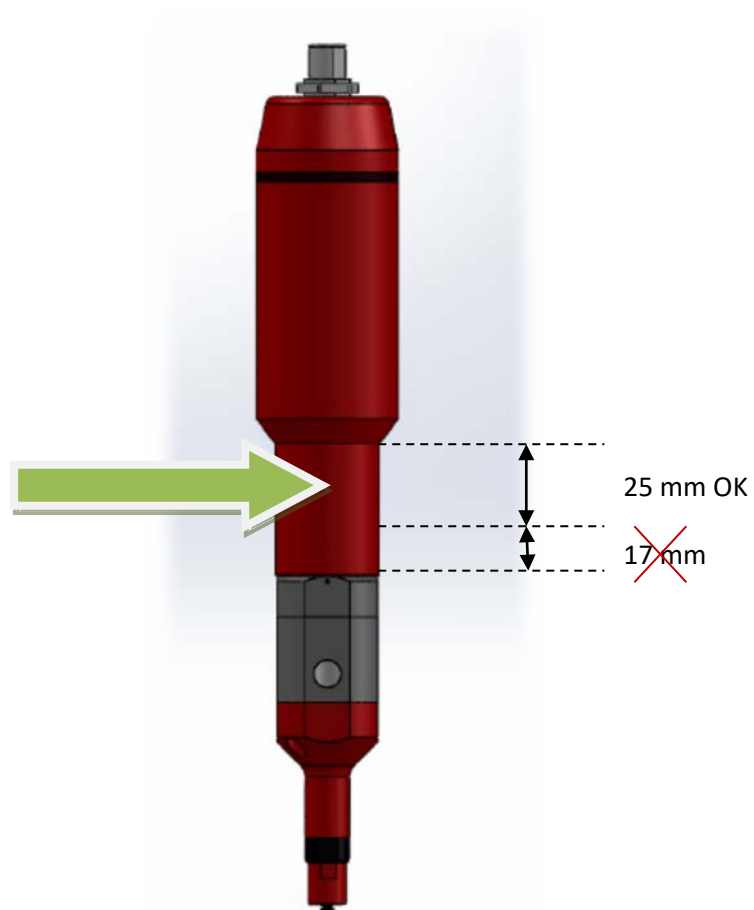

# Mini and micro dispensing solutions for fluids and pastes

